



# MANAJEMEN INTEGRASI INFORMASI DAN PERTUKARAN DATA (GOVERNMENT SERVICE BUS)

DIREKTORAT E-GOVERNMENT  
DITJEN. APLIKASI INFORMATIKA  
KEMENTERIAN KOMUNIKASI DAN INFORMATIKA

By: Didi Sukyadi

## OFFLINE



## ONLINE



## CYBERSPACE

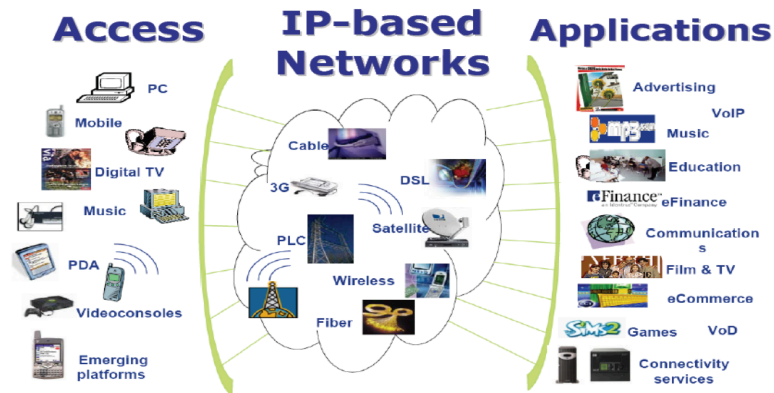

## PENDORONG PERUBAHAN

## TRANSFORMASI

- Norma, etika, pengetahuan, sosial, politik, dll, contoh: e-Literacy, e-Education, dll.
- Pemerintahan, contoh: e-Government, e-Procurement, dll.
- Niaga, contoh: e-Commerce, e-Business, dll.
- Transportasi, contoh: Gojek, Grab, Uber, dll.
- Keuangan, contoh: e-Banking, e-Payment, dll.

# PERMASALAHAN INTEGRASI

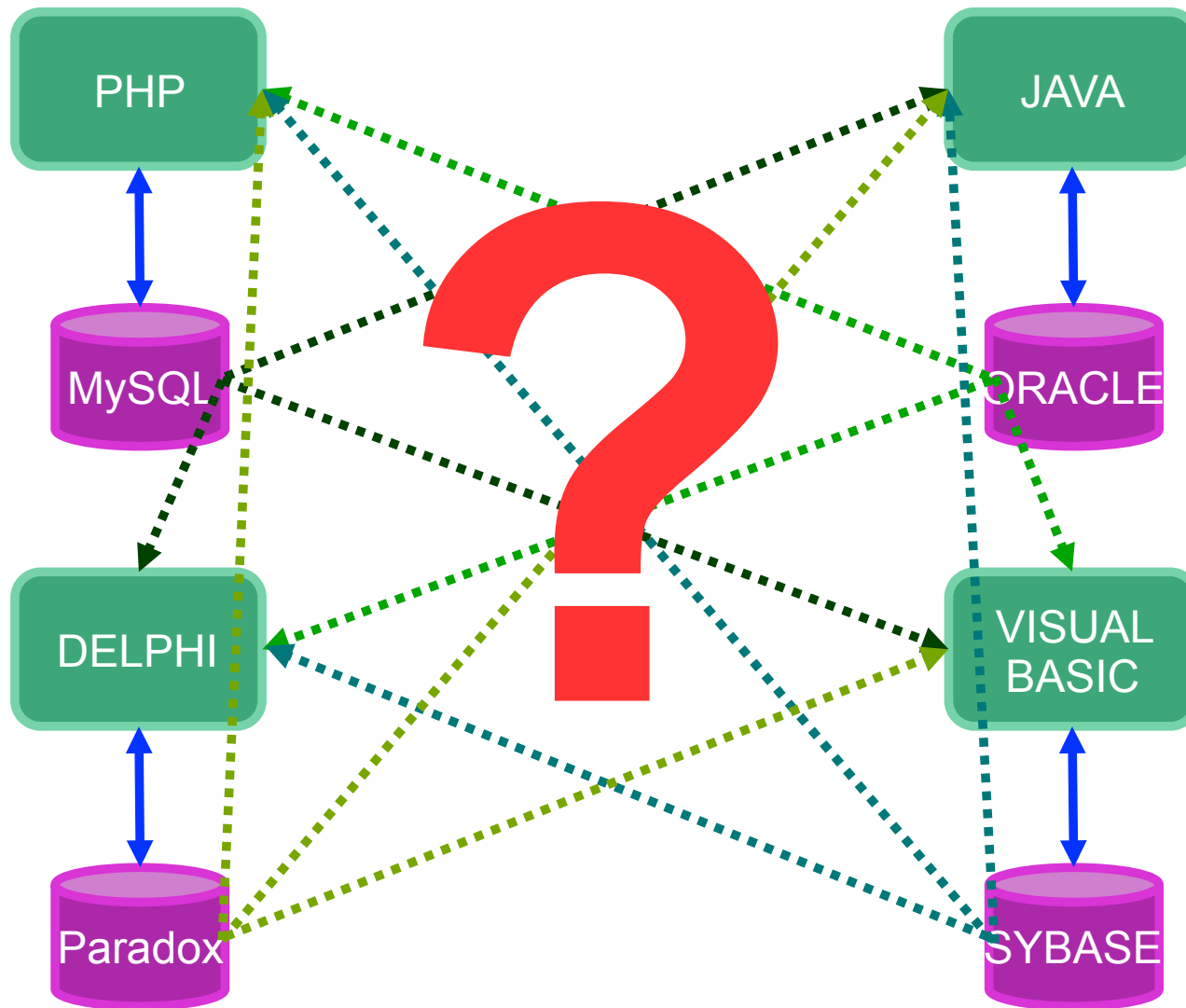

## Keragaman:

- Platform database
- Bahasa program
- Sistem operasi
- Infrastruktur

## Duplikasi:

- Referensi data
- Akses data
- Input data

## Kebutuhan:

- Ketersediaan data
- Keakuratan data
- Validasi data
- Verifikasi data
- Kecepatan akses
- Kemudahan akses

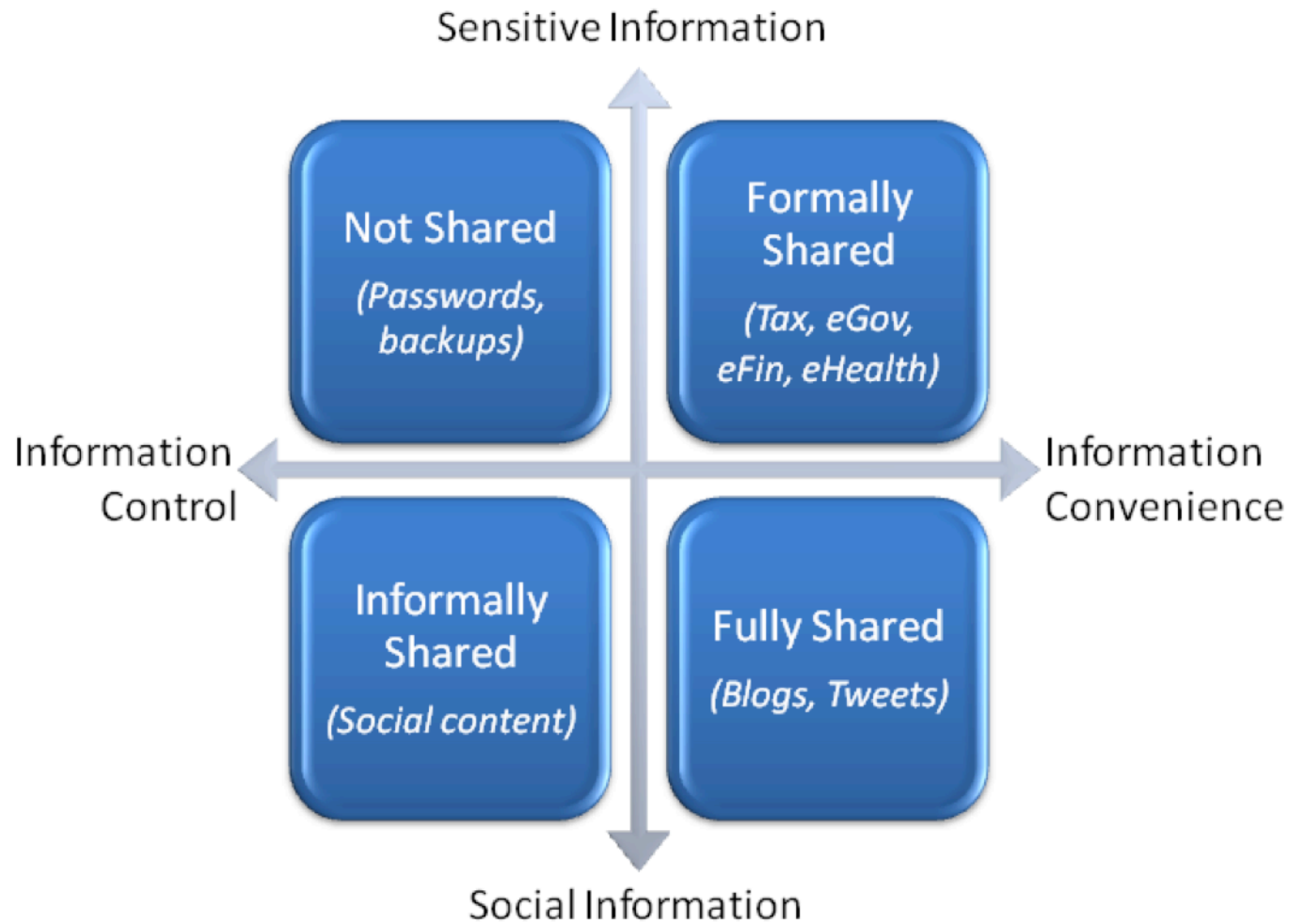



Perangkat pendukung kerangka kerja interoperabilitas untuk berbagi pakai data antar aplikasi berbasis teknologi Webservices dengan Arsitektur Berbasis Layanan (SOA: Service Oriented Architecture).

Manajemen API (Application Programming Interfaces) dengan Multiplatform Database dan pengaturan akses API berbasis Webservices

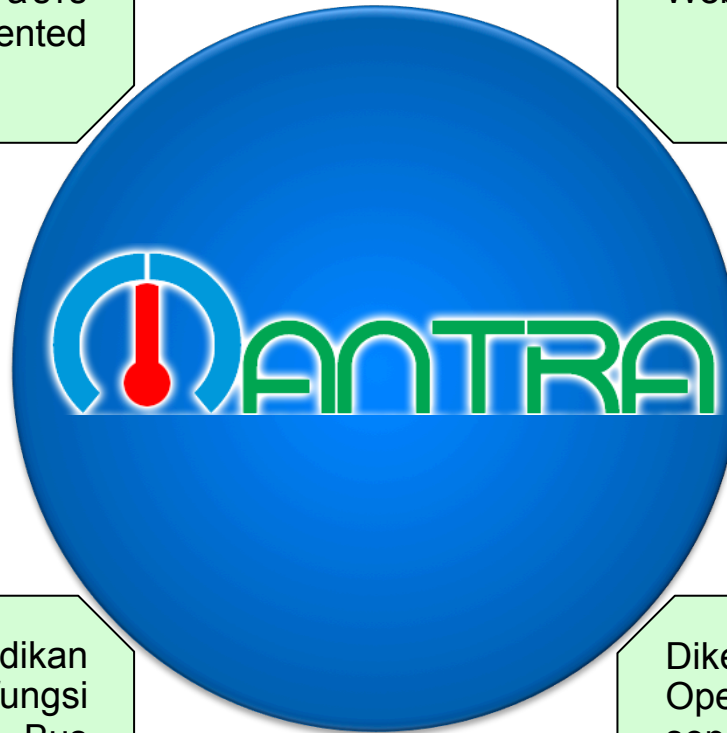

Manajemen antar API menjadikan aplikasi MANTRA dapat berfungsi sebagai Government Service Bus (GSB) untuk melayani akses data multiplatform antar API.

Dikembangkan dengan teknologi Open Source dan Open Standard seperti:

- Webservices: Apache
- API: PHP
- Protocol: HTTP/s
- Format: CSV, XML, JSON

# CARA KERJA API DAN WEBSERVICES

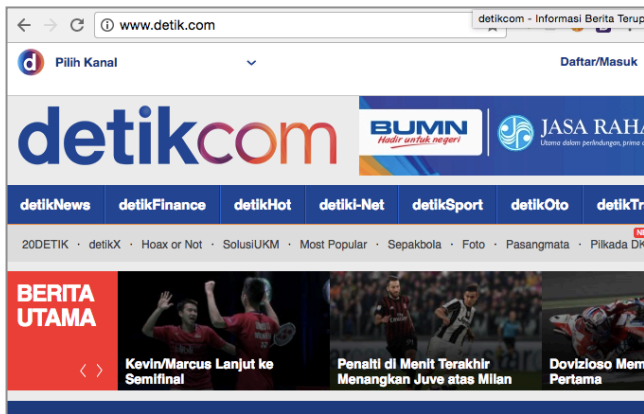
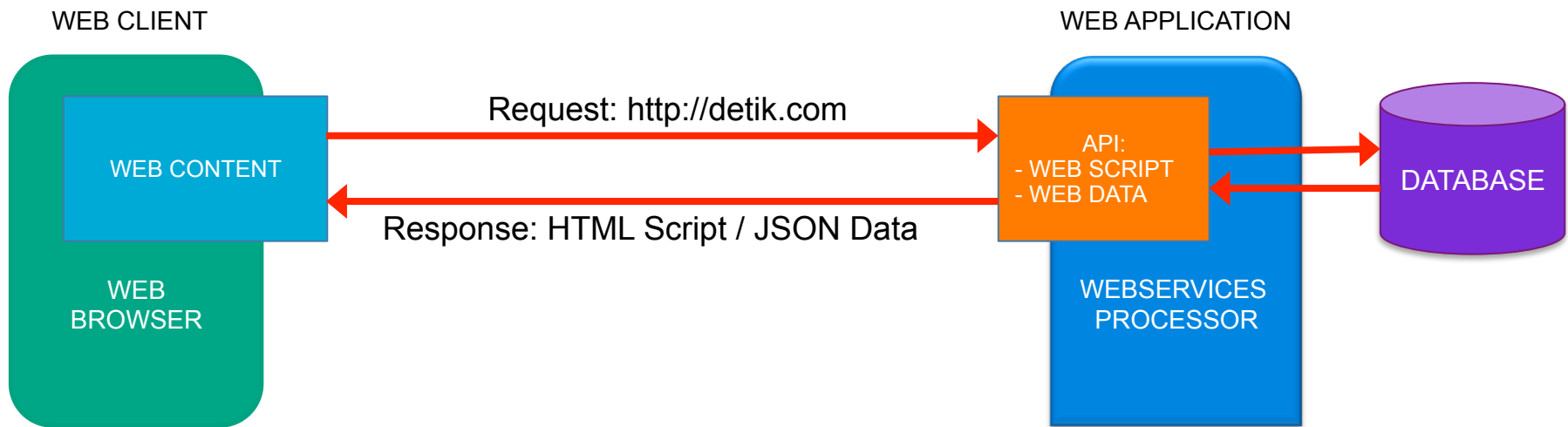

```

<!doctype html>
<html>
<head>
<meta charset="utf-8">
<meta http-equiv="X-UA-Compatible" content="text/html; charset=UTF-8" />
<meta name="viewport" content="width=device-width, initial-scale=1.0" />
<title>detikcom - Informasi Berita Terupdate Hari Ini</title>
  
```

# MODEL#1 INTEGRASI BERBASIS WEB

## 1. WEB CONTENT EMBEDDING (INTEGRATED USER INTERFACE) MENEMPATKAN ANTARMUKA APLIKASI WEB KE DALAM HALAMAN UTAMA PORTAL

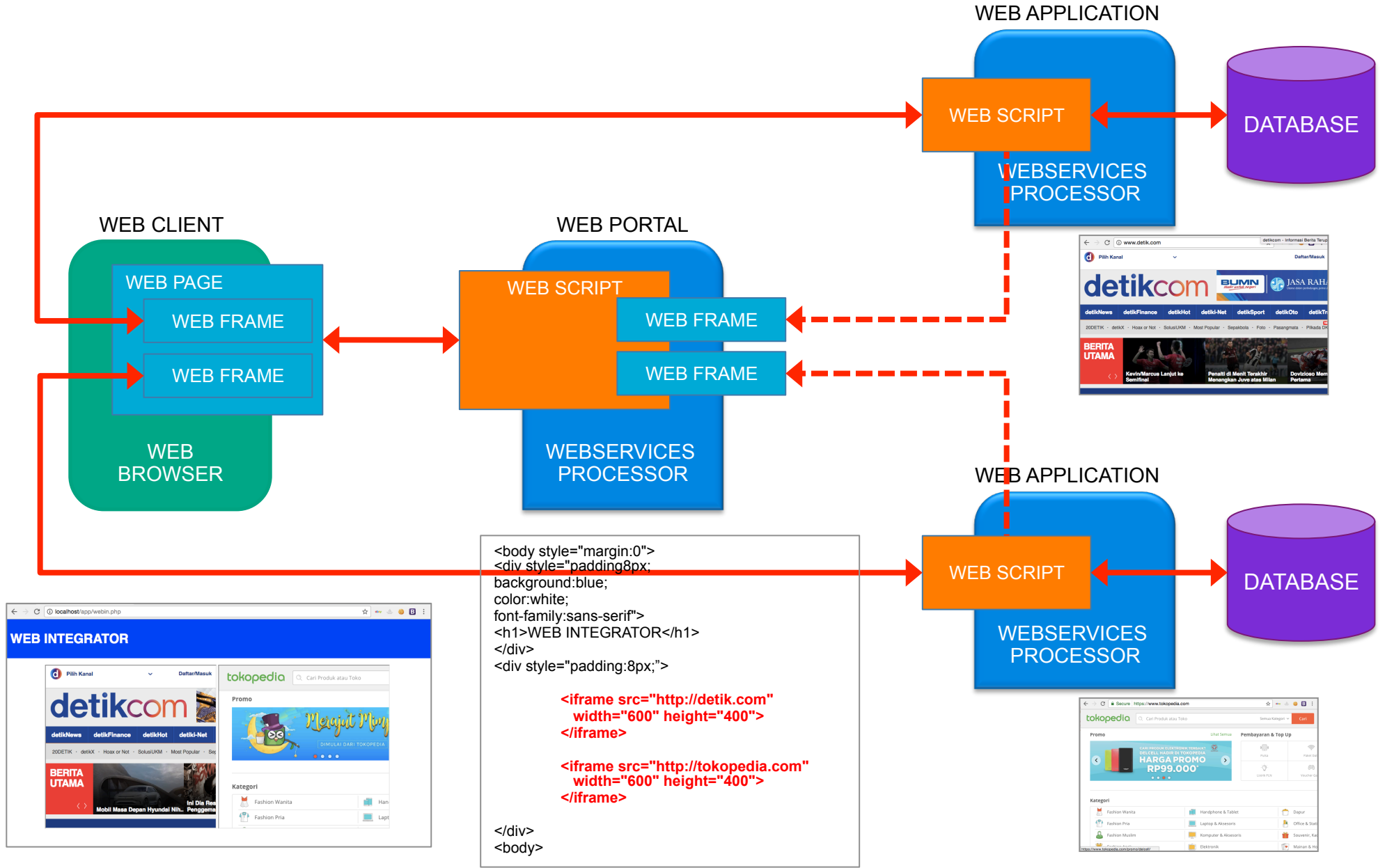

## 2. HYPERLINK VIA SINGLE SIGN ON PORTAL (INTEGRATED ACCESS WITH AUTHENTICATION) MENYEDIAKAN HYPERLINK APLIKASI WEB KE DALAM PORTAL SETELAH MELEWATI SATU OTENTIKASI

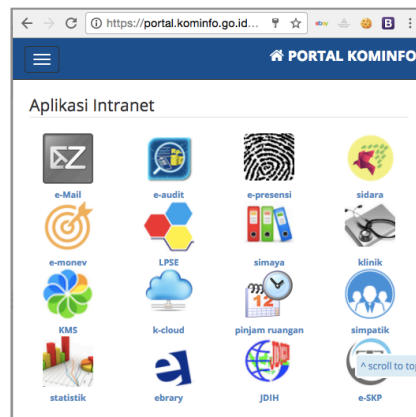
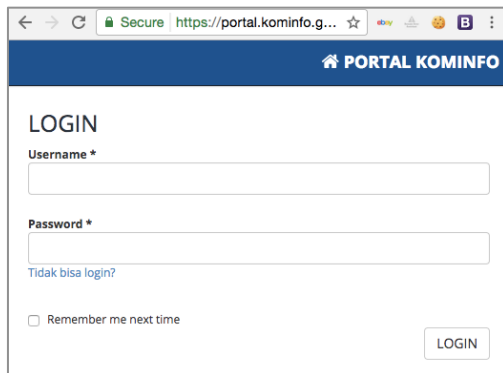
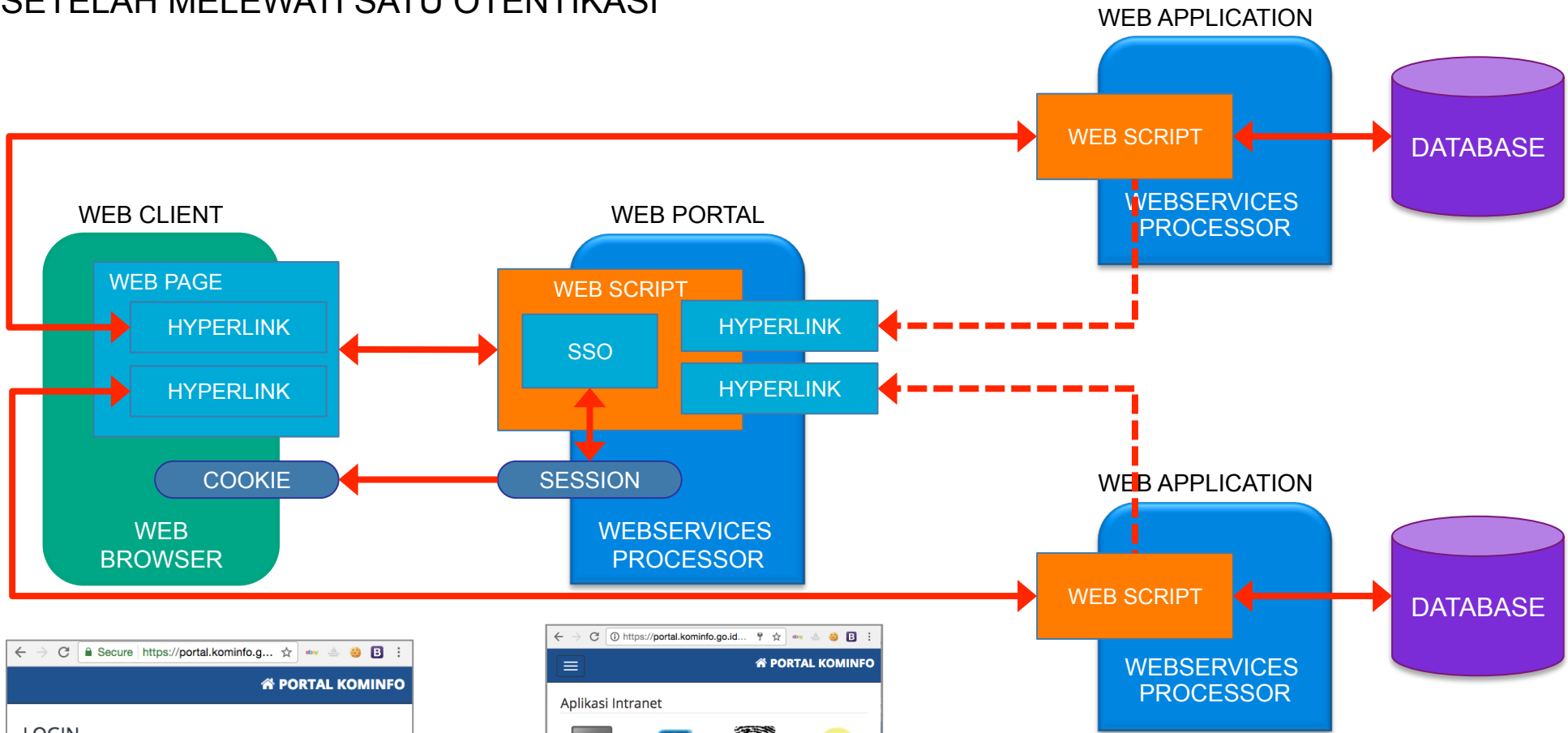



## 3. INTEGRATED SCRIPT/DATA USING DISTRIBUTED API BERBAGI PAKAI DATA MELALUI APPLICATION PROGRAMMING INTERFACE

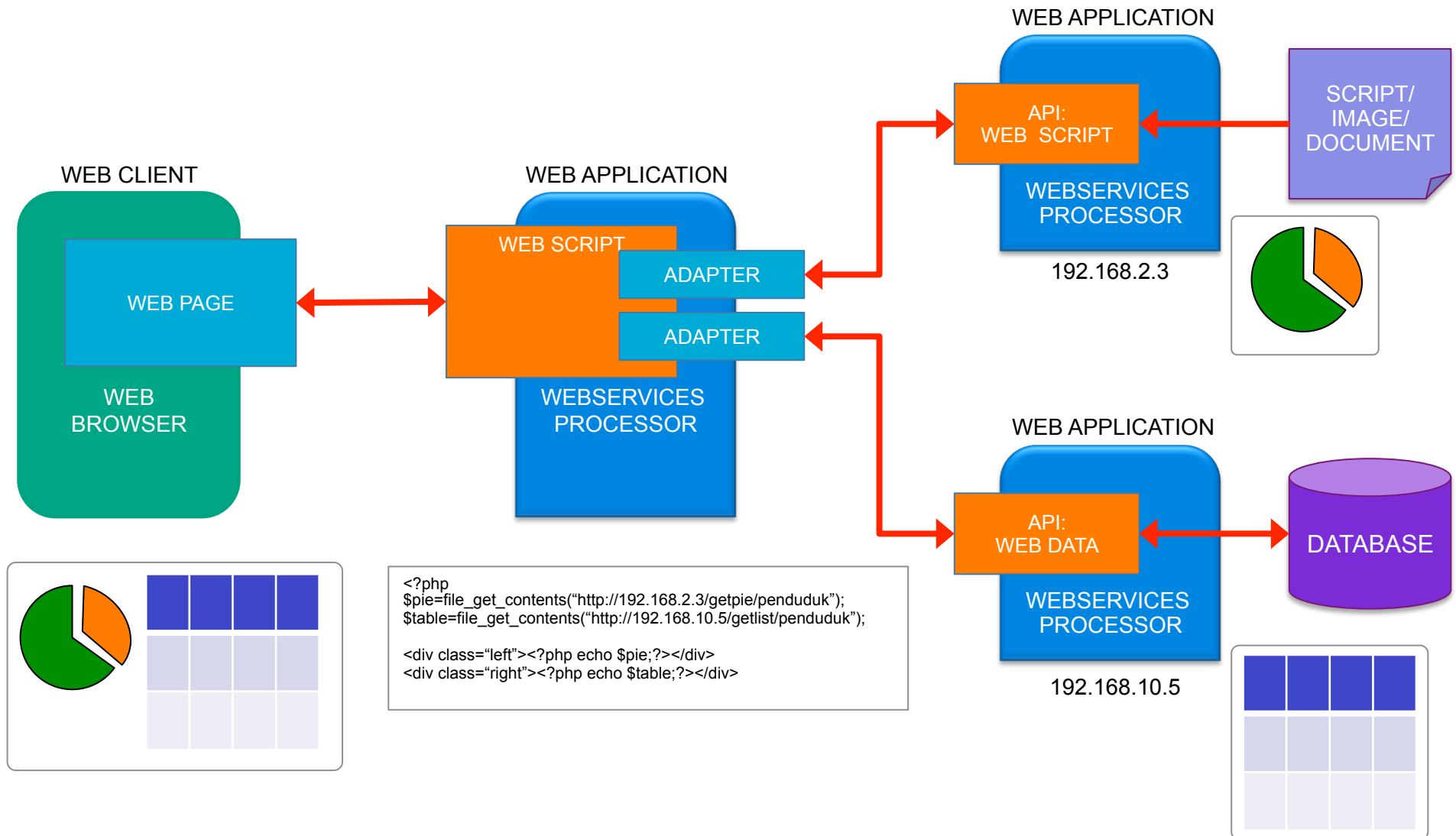

# SOLUSI INTEGRASI SISTEM HETEROGEN

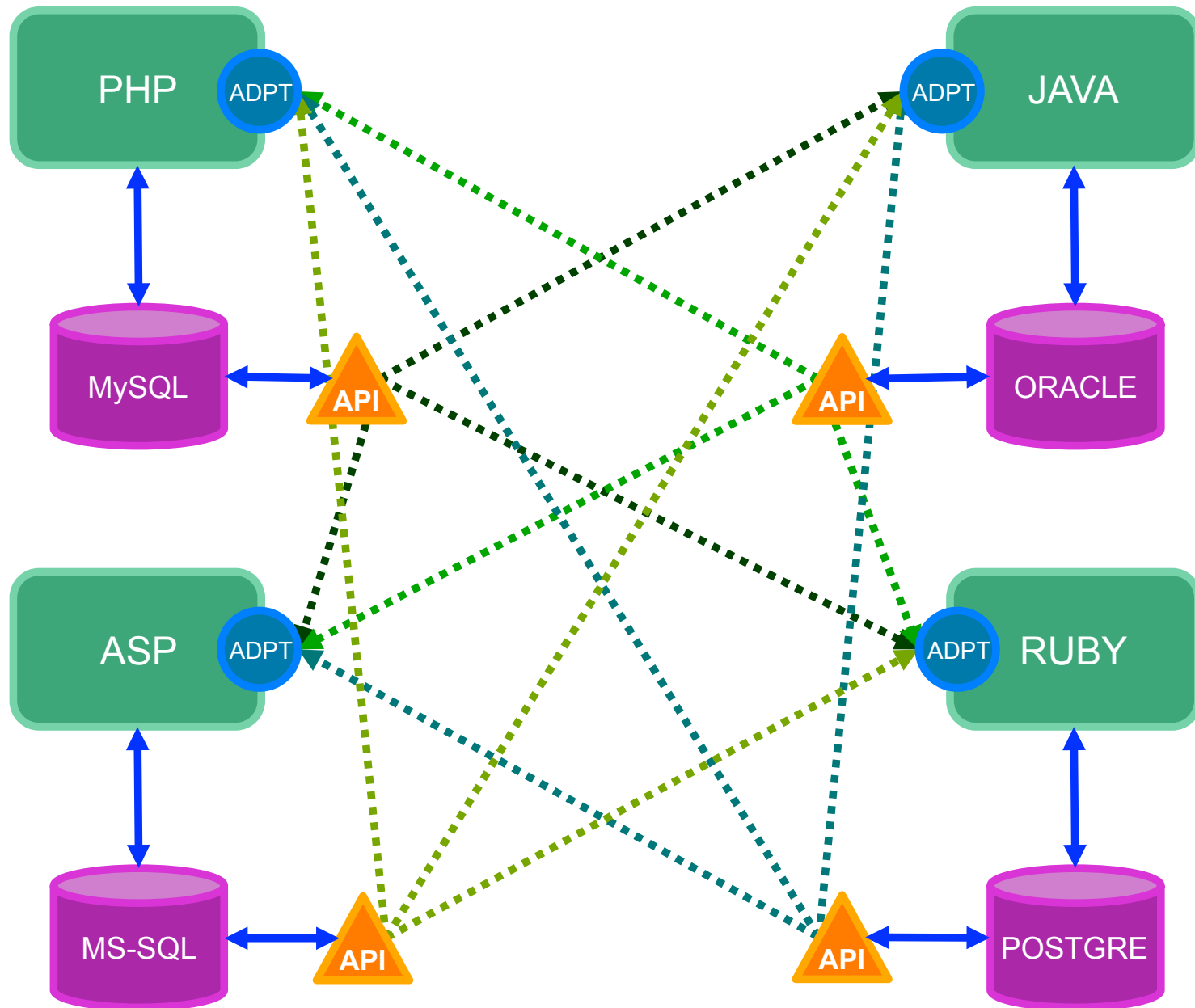

# ARSITEKTUR SOA PADA APLIKASI MANTRA

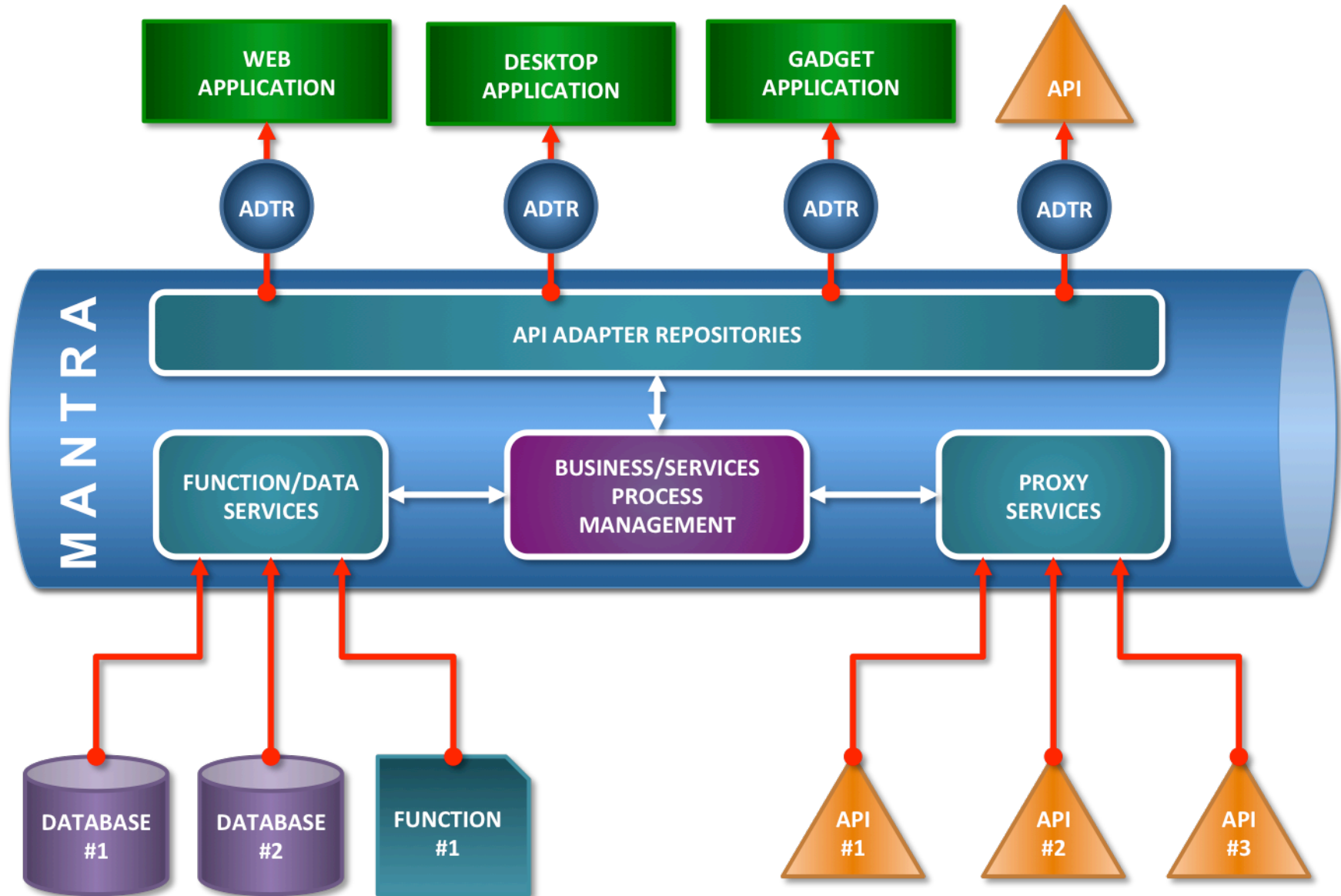

- Multiplatform Teknologi dengan Standar Terbuka (Open Standard Technology)
- Mendukung metode interoperabilitas: SOAP & REST
- Multiformat data: XML, JSON, PHP-Array, PHP-Serialize
- Mendukung DBMS: MySQL, PostgreSQL, MS-SQL, ORACLE, Interbase/Firebird
- GUI Manajemen (Link, File, Program, Data [Insert, Update, Delete, Select, Procedure])
- Memberikan peluang pengembangan berbasis Kode Sumber Terbuka (Open Source)
- Development Software:
  - Webservice Processor: Apache 2.4 Multi Process Management
  - Web Preprocessing: PHP 5.5
  - DBMS: MySQL 5.x
  - Operating System: Unix, Linux, Windows
- Hardware Requirement:
  - Processor: Hyper-Threading, RAM: 8GB, Storage: 100GB, NIC: 10/100Mbps
  - Bandwidth: 4 Mbps

# MODEL IMPLEMENTASI INTEROPERABILITAS

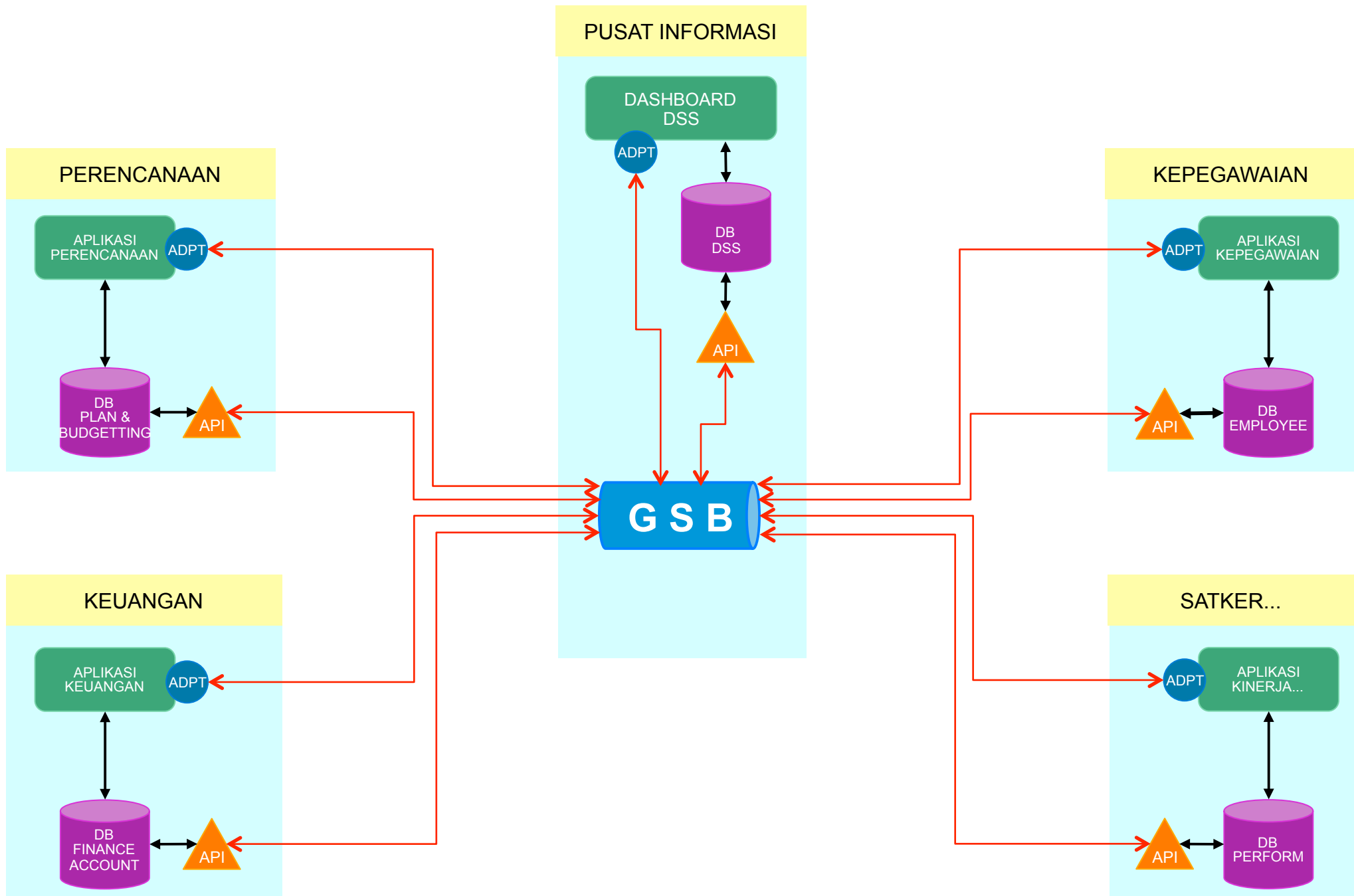



```
<?php
$url="http://192.168.4.10/json/getfungsi";
$accesskey="...";
$pardata=array("value"=>urlencode("..."));
$par="/".http_build_query($pardata);
$options=array('http'=>
    array(
        'method'=>"GET",
        'header'=>"User-Agent:... \r\nAccessKey:$accesskey"
    )
);
$content=stream_context_create($options);
$content=file_get_contents($url.$par,false,$content);
echo $content;
?>
```

# TAHAPAN PEMANFAATAN APLIKASI MANTRA

## PEMANFAAT DATA ELEKTRONIK



## PENGELOLA AKSES BERBAGI DATA ELEKTRONIK



## PENYEDIA DATA ELEKTRONIK

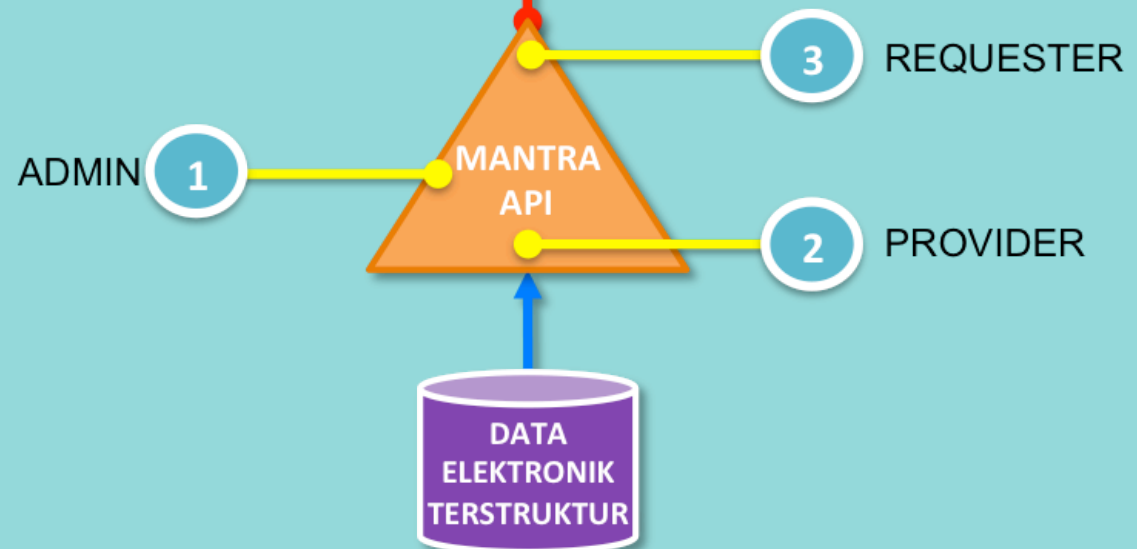

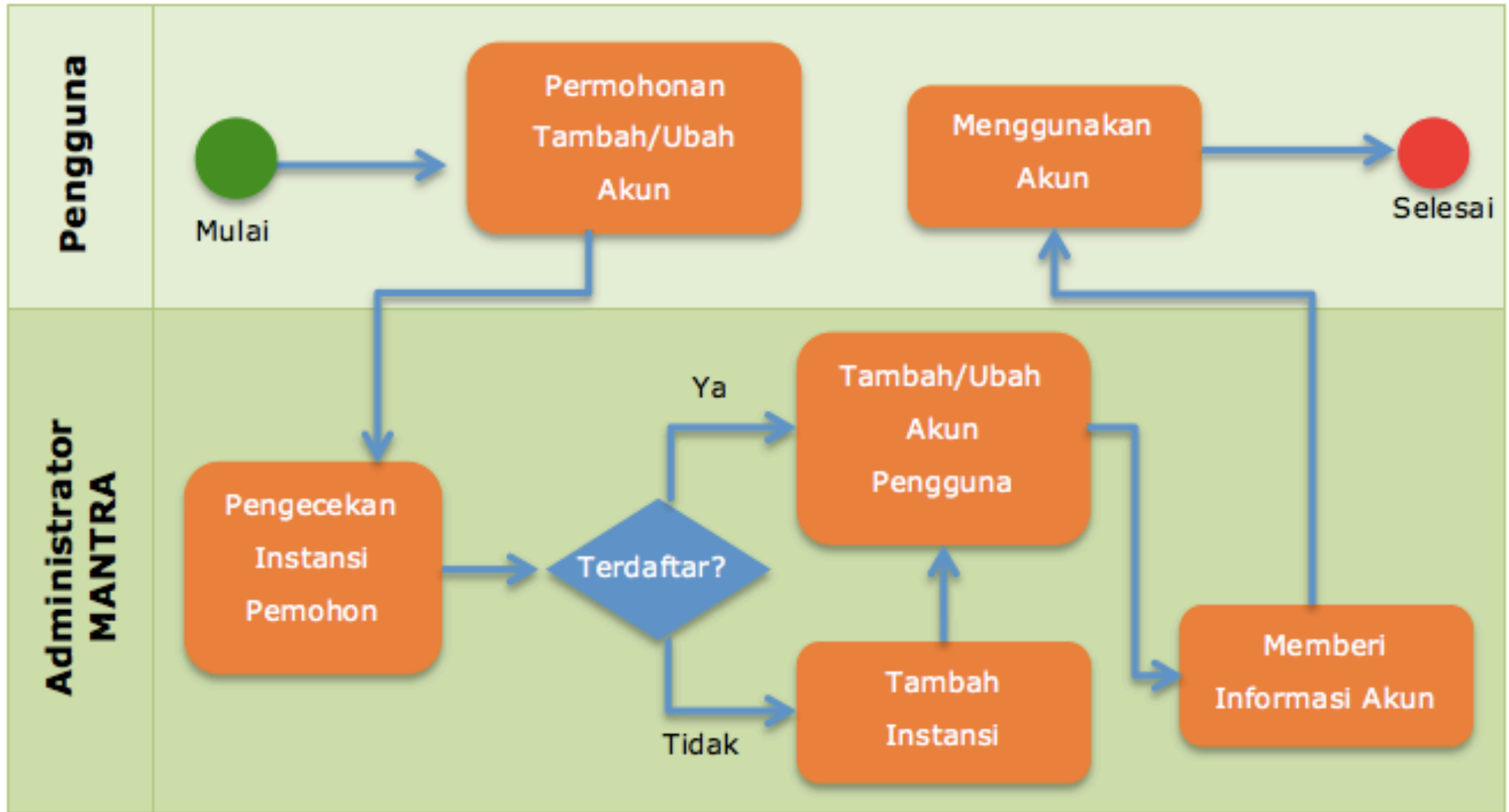

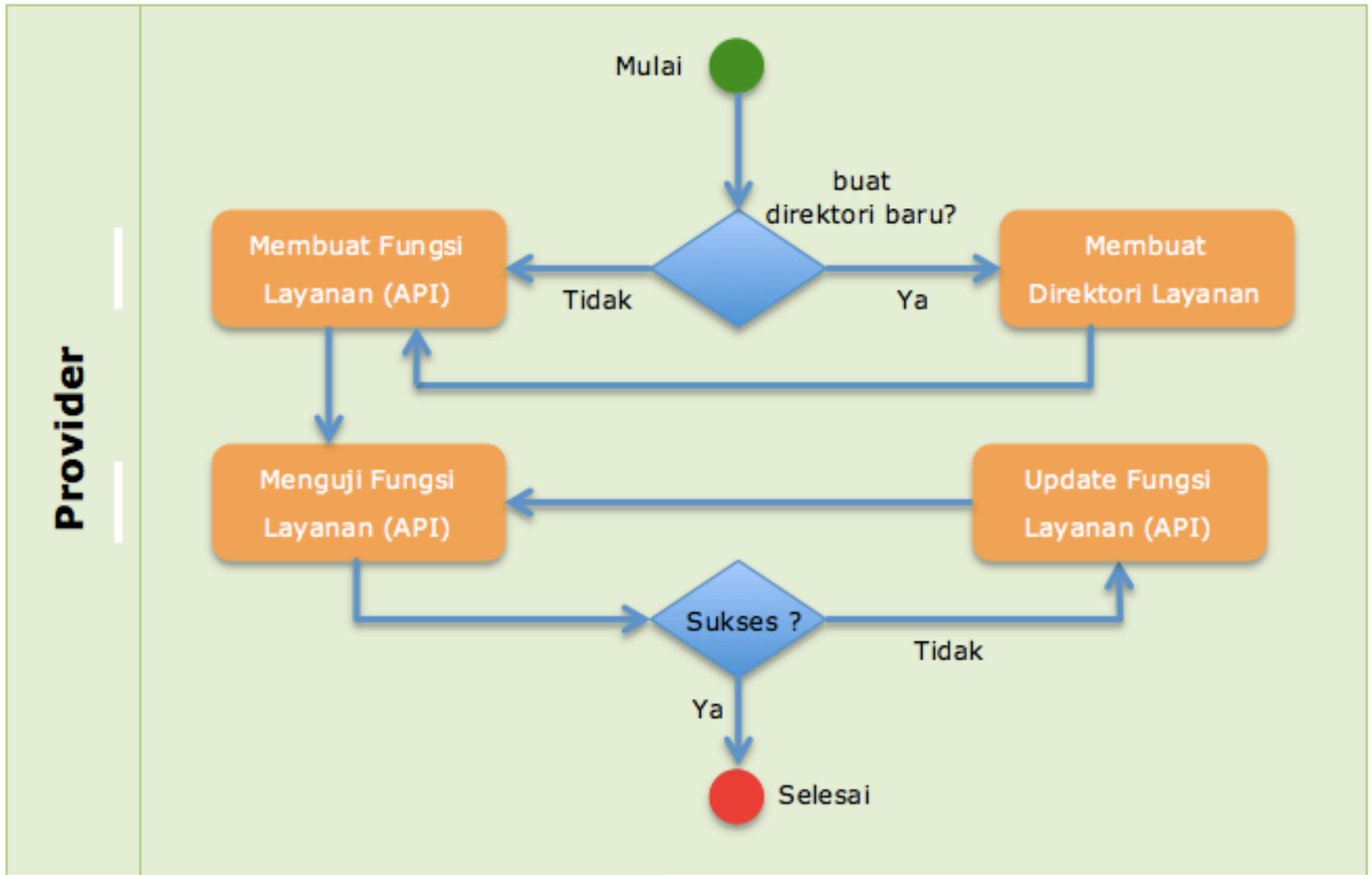

# TAHAP PERMINTAAN AKSES DARI PROVIDER

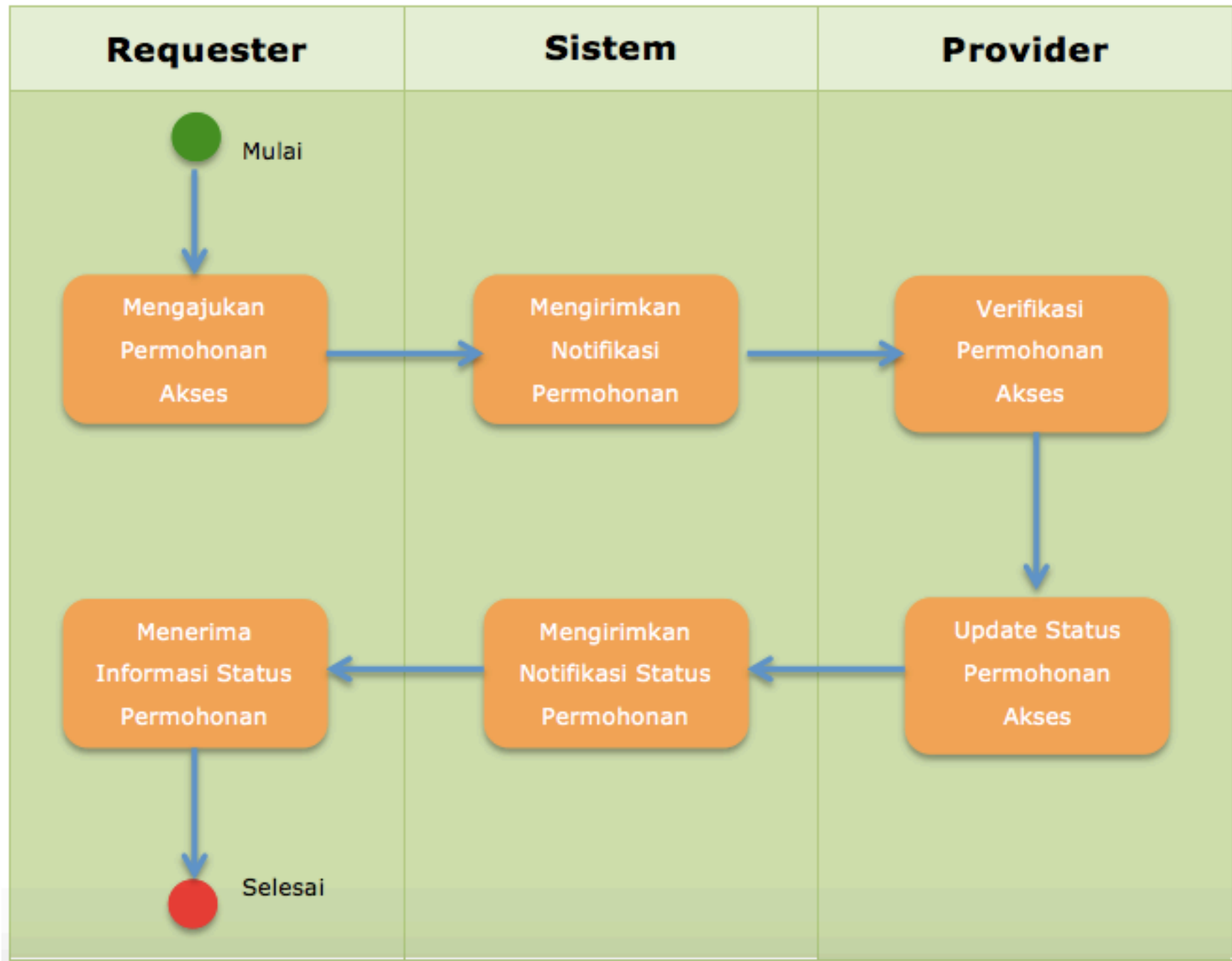



# TAHAP PUBLIKASI API #1

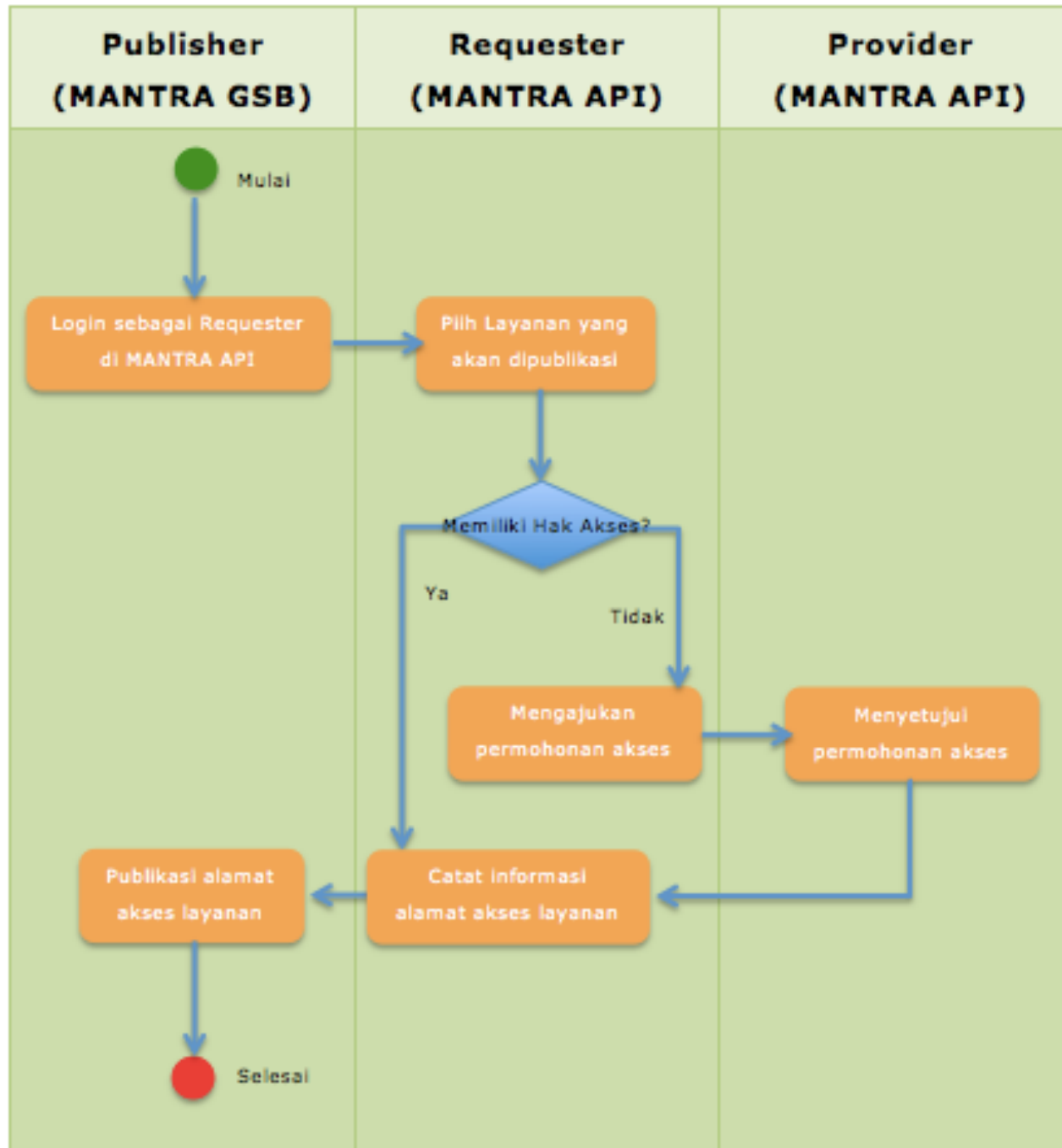

**Publisher**

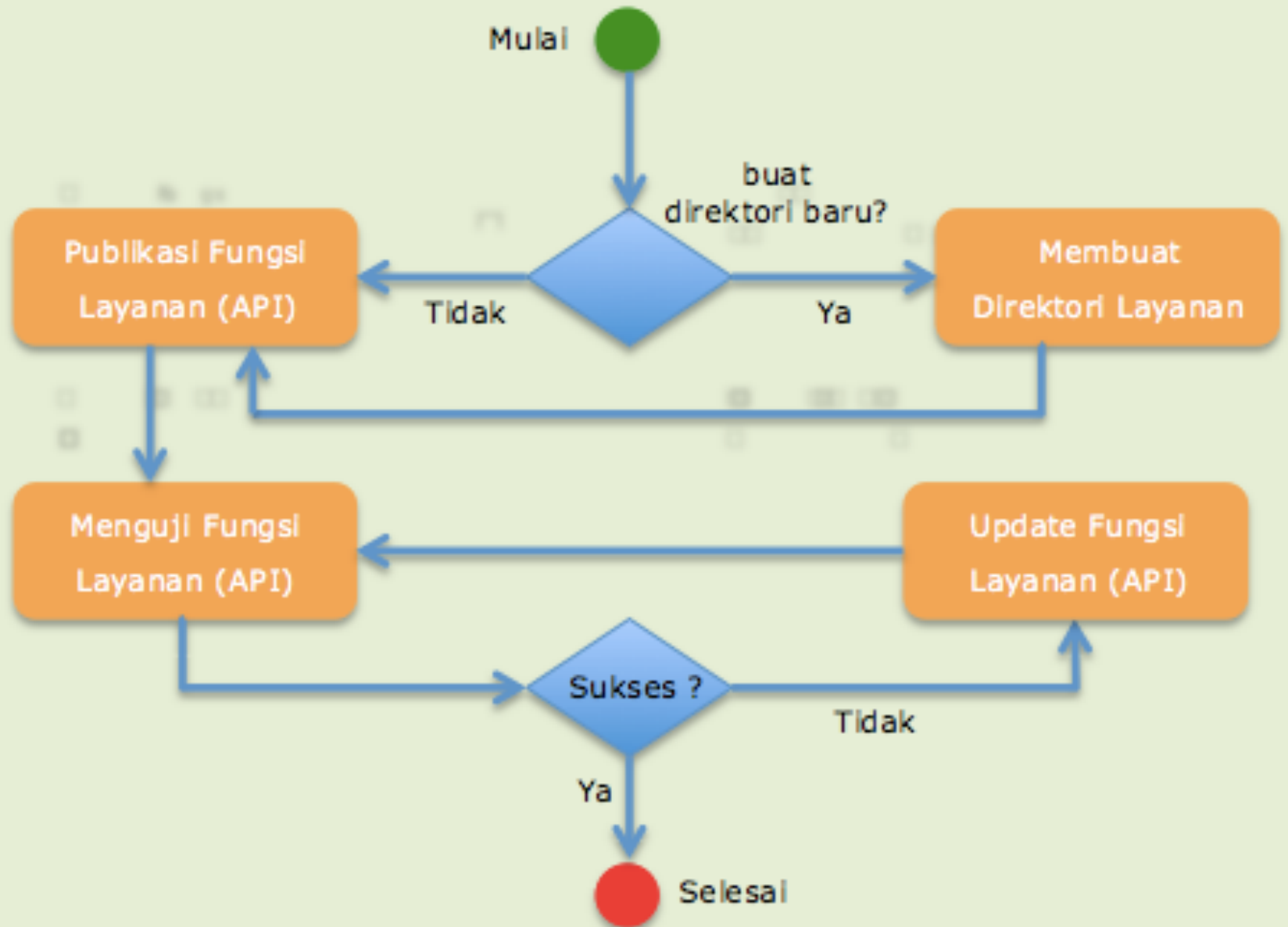

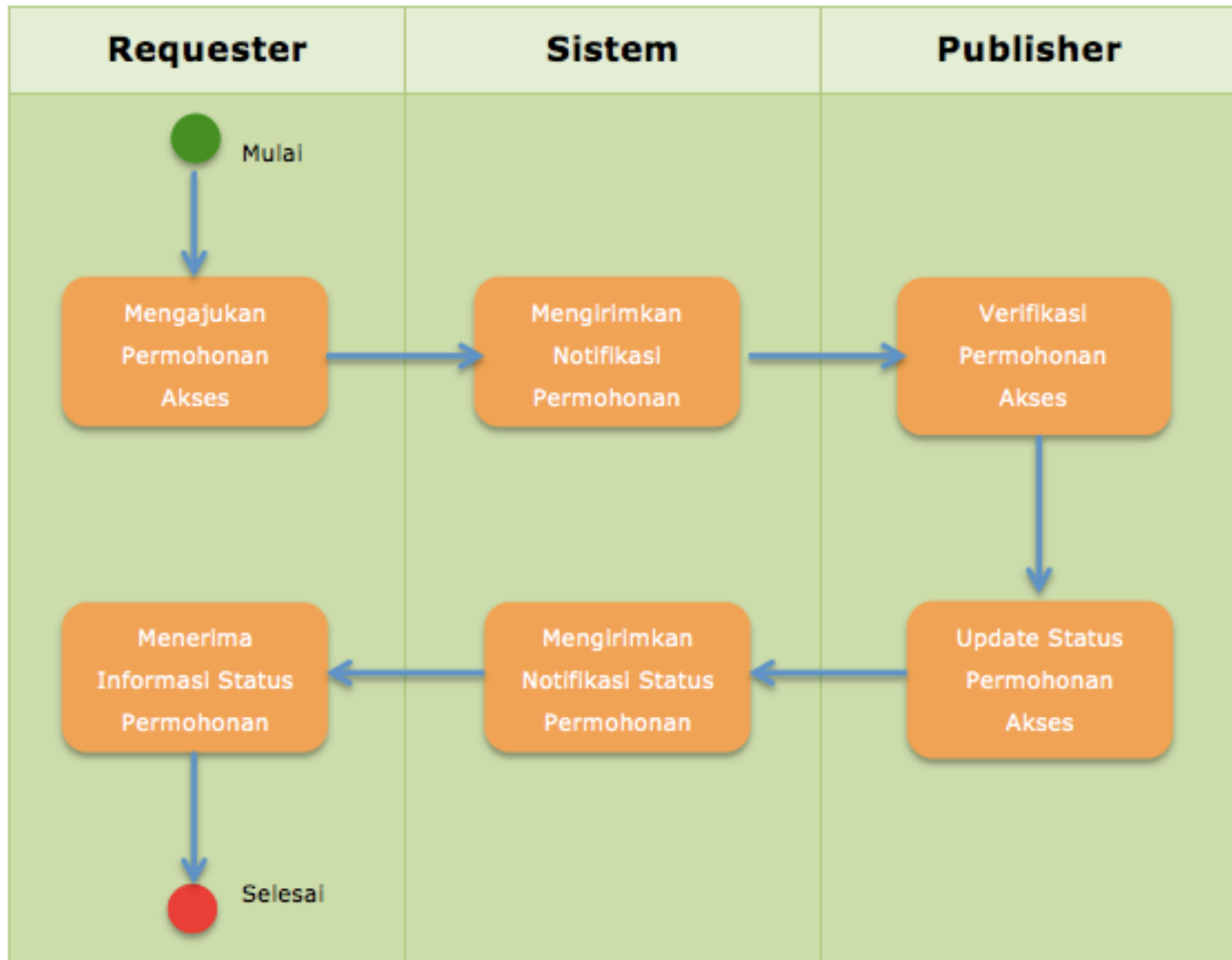

## 1. VERIFIKASI PERIJINAN

NO. PRINSIP	NAMA	JENIS IZIN	SYARAT	DURASI	TGL DAFTAR	TGL SELESAI
0001	ABC	LOKASI	J,K,L	14	15/04/2015	
0001	ABC	IMB	G,H,L			
0001	ABC	GANGGUAN				

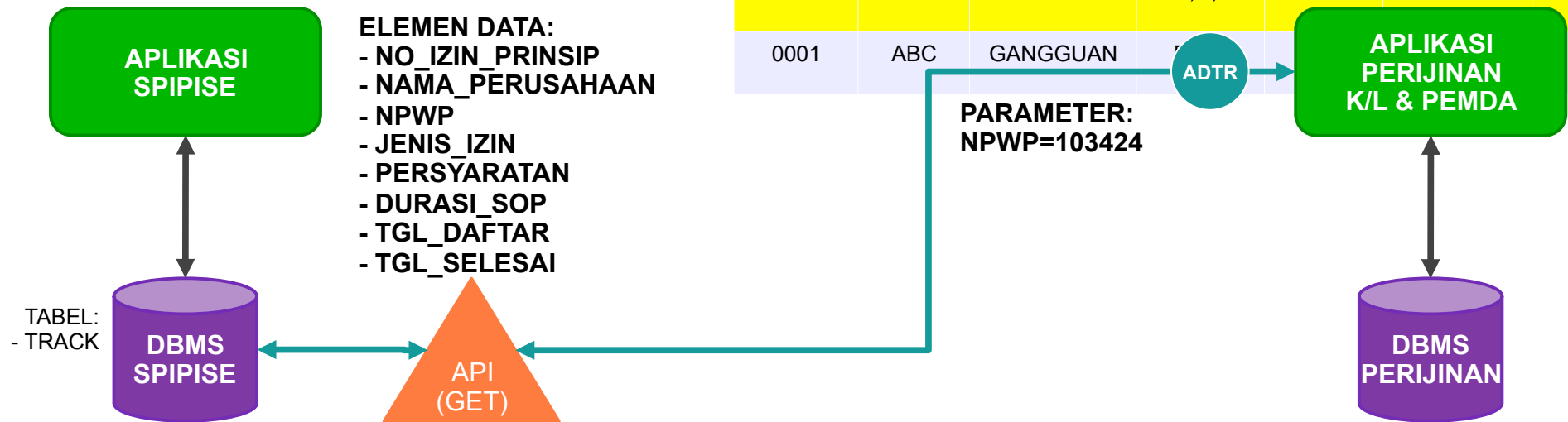

## 2. UPDATE/TRACKING PERIJINAN

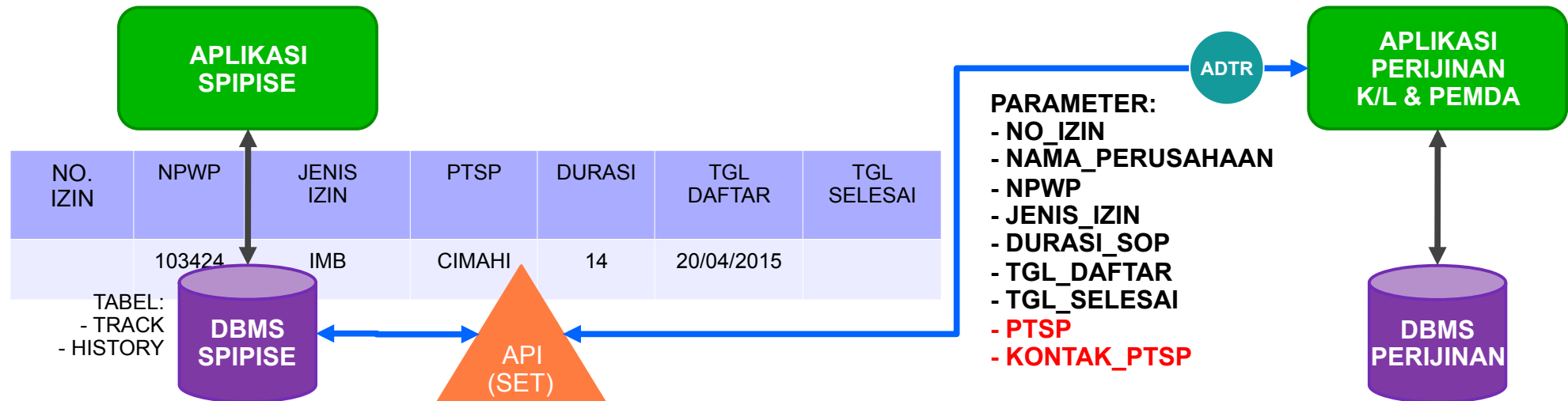

Surat Permohonan ditujukan ke:  
Dirjen. Aplikasi Informatika  
c/q: Direktur e-Government  
Perihal: Implementasi Aplikasi MANTRA

Mail:

[gabriel.setu@kominfo.go.id](mailto:gabriel.setu@kominfo.go.id)

[didi003@kominfo.go.id](mailto:didi003@kominfo.go.id)

[didiskd@gmail.com](mailto:didiskd@gmail.com)

[Ivan.syahreza@kominfo.go.id](mailto:Ivan.syahreza@kominfo.go.id)

Whatsapp:

Gabriel Setu: 085880957775

Didi Sukyadi: 082123280073

Ivan Syahreza: 081284088750

Repositori:

<https://groups.google.com/forum/#!forum/mantra-kemkominfo>



# TERIMA KASIH

...

DIDI SUKYADI, MTI  
[didiskd@gmail.com](mailto:didiskd@gmail.com) / [didi003@kominfo.go.id](mailto:didi003@kominfo.go.id)  
(082123280073)